

Made in the U.S.A.

Single Point Standard Brazed Carbide Tools



American Carbide Tool Company

STANDARD TOOL DIVISION

Manufacturers of High Quality, American Made
Single Point Carbide Tools in the widest range of sizes and styles
to meet your application requirements.

All products meet or exceed the ANSI specifications.

**CATALOG NO. 11-04
SUPERCEDES ALL PREVIOUS CATALOGS**



STRAIGHT TURNING TOOLS

AR & AL Style Tools - 0° Side Cutting Edge Angle

For Turning, Facing, or Boring to a square shoulder. A lead angle can be ground on the side cutting edge for use on shallow cuts or Chamfering.

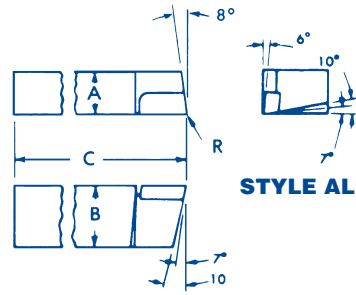

AR

TOOL NUMBER	SHANK DIMENSIONS			NOSE RADIUS	PKG QTY	Cast Iron & Non-Ferrous Grades				Steel Grades				Multi-purpose
	A	B	C			C2	C4	883	K68	C5	C6	370	K21	MICROGRAIN
AR-4	1/4	1/4	2	1/64	12	50503		50507	50511	50519	50520	50524	50528	50529
AR-5	5/16	5/16	2-1/4	1/64	12	50531	50546	50535	50539	50547	50548	50552	50556	50557
AR-6	3/8	3/8	2-1/2	1/64	12	50559	50574	50563	50567	50575	50576	50580	50584	50585
AR-7	7/16	7/16	3	1/32	12	50587	50602	50591	50595	50603	50604	50608	50612	50613
AR-8	1/2	1/2	3-1/2	1/32	12	50615	50630	50619	50623	50631	50632	50636	50640	50641
AR-10	5/8	5/8	4	1/32	12	50643		50647	50651	50659	50660	50664	50668	50669
AR-12	3/4	3/4	4-1/2	1/32	12	50671		50675	50679	50687	50688	50692	50696	50697
AR-16	1	1	7	1/32	6	50699		50703		50715	50716	50720		
AR-20	1-1/4	1-1/4	8	1/32	Bulk	50727				50743	50744			
AR-24	1-1/2	1-1/2	8	1/16	Bulk	50755				50771	50772			
AR-44	1/2	1	7	1/32	6	50783				50799	50800			
AR-54	5/8	1	6	1/32	Bulk	50811				50827	50828			
AR-55	5/8	1-1/4	8	1/32	Bulk	50839				50855	50856			
AR-64	3/4	1	6	1/32	Bulk	50867				50883	50884			
AR-66	3/4	1-1/2	8	1/32	Bulk	50895				50911	50912			
AR-85	1	1-1/4	8	1/32	Bulk	50923				50939	50940			
AR-86	1	1-1/2	8	1/32	Bulk	50951				50967	50968			

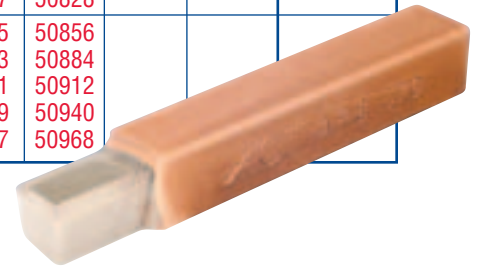

AL

TOOL NUMBER	SHANK DIMENSIONS			NOSE RADIUS	PKG QTY	Cast Iron & Non-Ferrous Grades				Steel Grades				Multi-purpose
	A	B	C			C2	C4	883	K68	C5	C6	370	K21	MICROGRAIN
AL-4	1/4	1/4	2	1/64	12	50003		50007	50011	50019	50020	50024	50028	50029
AL-5	5/16	5/16	2-1/4	1/64	12	50031	50046	50035	50039	50047	50048	50052	50056	50057
AL-6	3/8	3/8	2-1/2	1/64	12	50059	50074	50063	50067	50075	50076	50080	50084	50085
AL-7	7/16	7/16	3	1/32	12	50087	50102	50091	50095	50103	50104	50108	50112	50113
AL-8	1/2	1/2	3-1/2	1/32	12	50115	50130	50119	50123	50131	50132	50136	50140	50141
AL-10	5/8	5/8	4	1/32	12	50143		50147	50151	50159	50160	50164	50168	50169
AL-12	3/4	3/4	4-1/2	1/32	12	50171		50175	50179	50187	50188	50192	50196	50197
AL-16	1	1	7	1/32	6	50199				50215	50216	50220		
AL-20	1-1/4	1-1/4	8	1/32	Bulk	50227				50243	50244			
AL-24	1-1/2	1-1/2	8	1/16	Bulk	50255				50271	50272			
AL-44	1/2	1	7	1/32	6	50283				50299	50300			
AL-54	5/8	1	6	1/32	Bulk	50311				50327	50328			
AL-55	5/8	1-1/4	8	1/32	Bulk	50339				50355	50356			
AL-64	3/4	1	6	1/32	Bulk	50367				50383	50384			
AL-66	3/4	1-1/2	8	1/32	Bulk	50395				50411	50412			
AL-85	1	1-1/4	8	1/32	Bulk	50423				50439	50440			
AL-86	1	1-1/2	8	1/32	Bulk	50451				50467	50468			

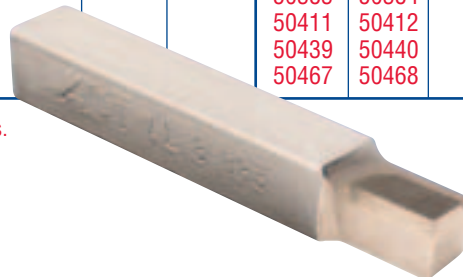

Red stock numbers indicate non-stock items. Quantity extra charge applies.

LEAD ANGLE TURNING TOOLS

BR & BL Style Tools - 15° Side Cutting Edge Angle

For interrupted or irregular cuts. Side edge angle provides gradual entrance to the workpiece. Lead angle distributes cutting load.

For Turning, Light Planing, Boring, Milling, and Facing.

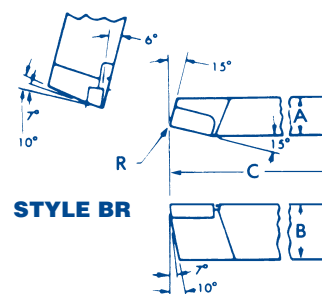

STYLE BR

BR

TOOL NUMBER	SHANK DIMENSIONS			NOSE RADIUS	PKG QTY	Cast Iron & Non-Ferrous Grades				Steel Grades				Multi-purpose
	A	B	C			C2	C4	883	K68	C5	C6	370	K21	MICROGRAIN
BR-4	1/4	1/4	2	1/64	12	51503		51507	51511	51519	51520	51524	51528	51529
BR-5	5/16	5/16	2-1/4	1/64	12	51531		51535	51539	51547	51548	51552	51556	51557
BR-6	3/8	3/8	2-1/2	1/64	12	51559	51574	51563	51567	51575	51576	51580	51584	51585
BR-7	7/16	7/16	3	1/32	12	51587	51602	51591	51595	51603	51604	51608	51612	51613
BR-8	1/2	1/2	3-1/2	1/32	12	51615	51630	51619	51623	51631	51632	51636	51640	51641
BR-10	5/8	5/8	4	1/32	12	51643		51647	51651	51659	51660	51664	51668	51669
BR-12	3/4	3/4	4-1/2	1/32	12	51671		51675	51679	51687	51688	51692	51696	51697
BR-16	1	1	7	1/32	6	51699		51703		51715	51716			
BR-20	1-1/4	1-1/4	8	1/32	Bulk	51727				51743	51744			
BR-24	1-1/2	1-1/2	8	1/16	Bulk	51755				51771	51772			
BR-44	1/2	1	7	1/32	6	51783				51799	51800			
BR-54	5/8	1	6	1/32	Bulk	51811				51827	51828			
BR-55	5/8	1-1/4	8	1/32	Bulk	51839				51855	51856			
BR-64	3/4	1	6	1/32	Bulk	51867				51883	51884			
BR-66	3/4	1-1/2	8	1/32	Bulk	51895				51911	51912			
BR-85	1	1-1/4	8	1/32	Bulk	51923				51939	51940			
BR-86	1	1-1/2	8	1/32	Bulk	51951				51967	51968			



BL

TOOL NUMBER	SHANK DIMENSIONS			NOSE RADIUS	PKG QTY	Cast Iron & Non-Ferrous Grades				Steel Grades				Multi-purpose
	A	B	C			C2	C4	883	K68	C5	C6	370	K21	MICROGRAIN
BL-4	1/4	1/4	2	1/64	12	51003		51007	51011	51019	51020	51024	51028	51029
BL-5	5/16	5/16	2-1/4	1/64	12	51031		51035	51039	51047	51048	51052	51056	51057
BL-6	3/8	3/8	2-1/2	1/64	12	51059	51074	51063	51067	51075	51076	51080	51084	51085
BL-7	7/16	7/16	3	1/32	12	51087	51102	51091	51095	51103	51104	51108	51112	51113
BL-8	1/2	1/2	3-1/2	1/32	12	51115	51130	51119	51123	51131	51132	51136	51140	51141
BL-10	5/8	5/8	4	1/32	12	51143		51147	51151	51159	51160	51164	51168	51169
BL-12	3/4	3/4	4-1/2	1/32	12	51171		51175	51179	51187	51188	51192	51196	51197
BL-16	1	1	7	1/32	6	51199		51203		51215	51216			
BL-20	1-1/4	1-1/4	8	1/32	Bulk	51227				51243	51244			
BL-24	1-1/2	1-1/2	8	1/16	Bulk	51255				51271	51272			
BL-44	1/2	1	7	1/32	6	51283				51299	51300			
BL-54	5/8	1	6	1/32	Bulk	51311				51327	51328			
BL-55	5/8	1-1/4	8	1/32	Bulk	51339				51355	51356			
BL-64	3/4	1	6	1/32	Bulk	51367				51383	51384			
BL-66	3/4	1-1/2	8	1/32	Bulk	51395				51411	51412			
BL-85	1	1-1/4	8	1/32	Bulk	51423				51439	51440			
BL-86	1	1-1/2	8	1/32	Bulk	51451				51467	51468			

Red stock numbers indicate non-stock items. Quantity extra charge applies.



SQUARE NOSE UTILITY TOOL

C Style Tool - 0° Square Nose

Allows for right or left hand cutting.
For use in Forming, Turning,
Facing, Chamfering, and
Grooving applications.

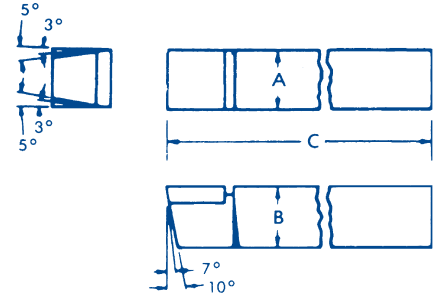

C

TOOL NUMBER	SHANK DIMENSIONS			PKG QTY	Cast Iron & Non-Ferrous Grades				Steel Grades				Multi-purpose
	A	B	C		C2	C4	883	K68	C5	C6	370	K21	MICROGRAIN
C-4	1/4	1/4	2	12	52003		52007	52011	52019	52020	52024	52028	52029
C-5	5/16	5/16	2-1/4	12	52031		52035	52039	52047	52048	52052	52056	52057
C-6	3/8	3/8	2-1/2	12	52059	52074	52063	52067	52075	52076	52080	52084	52085
C-7	7/16	7/16	3	12	52087		52091	52095	52103	52104	52108	52112	52113
C-8	1/2	1/2	3-1/2	12	52115		52119	52123	52131	52132	52136	52140	52141
C-10	5/8	5/8	4	12	52143		52147	52151	52159	52160	52164	52168	52169
C-12	3/4	3/4	4-1/2	12	52171		52175	52179	52187	52188	52192	52196	52197
C-16	1	1	7	6	52199		52203		52215	52216	52220		
C-20	1-1/4	1-1/4	8	Bulk	52227				52243	52244			
C-44	1/2	1	7	6	52283		52287		52299	52300	52304		
C-54	5/8	1	6	Bulk	52311				52327	52328			
C-55	5/8	1-1/4	8	Bulk	52339				52355	52356			
C-64	3/4	1	6	Bulk	52367				52383	52384			
C-66	3/4	1-1/2	8	Bulk	52395				52411	52412			
C-86	1	1-1/2	8	Bulk	52451				52467	52468			

CUTOFF TOOLS

CT(COR) & CTL(COL) Style

For Cutoff or Grooving of solid bars and tubing stock.



STYLE CT

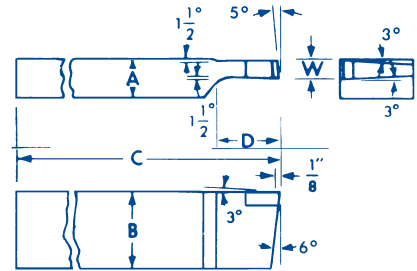

CT(COR) & CTL(COL)

TOOL NUMBER	SHANK DIMENSIONS					PKG QTY	Cast Iron & Non-Ferrous Grades		Steel Grades			Multi-purpose
	A	B	C	D	W		C2	883	C5	C6	370	MICROGRAIN
CT-111	1/2	1	5	3/4	1/8	6	52503	52507	52519	52520	52524	52529
CT-122(433)	1/2	1	5	13/16	3/16	6	52531	52535	52547	52548	52552	52557
CT-120(445)	1/2	1	5	1	5/16	6	52559		52575	52576	52580	52585
CT-121(444)	1/2	1	5	1	1/4	6	52587	52591	52603	52604	52608	52613
CT-130(556)	5/8	1-1/4	5	1-1/4	3/8	6	52615	52619	52631	52632	52636	52641
CT-140(666)	3/4	1-1/2	6	1-1/4	3/8	6	52643		52659	52660	52664	52669
CTL-111	1/2	1	5	3/4	1/8	6	52783	52787	52799	52800	52804	
CTL-122(433)	1/2	1	5	13/16	3/16	6	52811	52815	52827	52828	52832	52837
CTL-120(445)	1/2	1	5	1	5/16	6	52839		52855	52856	52860	52865
CTL-121(444)	1/2	1	5	1	1/4	6	52867	52871	52883	52884	52888	52893
CTL-130(556)	5/8	1-1/4	5	1-1/4	3/8	6	52895	52899	52911	52912	52916	52921
CTL-140(666)	3/4	1-1/2	6	1-1/4	3/8	6	52923		52939	52940	52944	52949

Red stock numbers indicate non-stock items. Quantity extra charge applies.

POINTED NOSE UTILITY TOOL

D Style Tool - 80° Included Angle

Allows for right or left hand cutting.
For use in Light Turning, Undercutting,
Chamfering, and Boring applications.

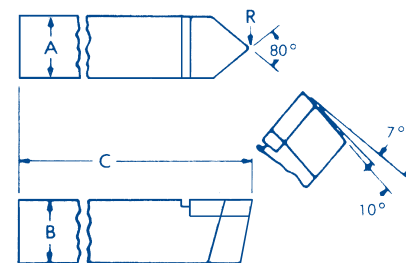

D

TOOL NUMBER	SHANK DIMENSIONS			NOSE RADIUS	PKG QTY	Cast Iron & Non-Ferrous Grades				Steel Grades				Multi-purpose
	A	B	C			C2	C4	883	K68	C5	C6	370	K21	MICROGRAIN
D-4	1/4	1/4	2	1/64	12	53003		53007	53011	53019	53020	53024	53028	53029
D-5	5/16	5/16	2-1/4	1/64	12	53031		53035	53039	53047	53048	53052	53056	53057
D-6	3/8	3/8	2-1/2	1/64	12	53059	53074	53063	53067	53075	53076	53080	53084	53085
D-7	7/16	7/16	3	1/32	12	53087		53091	53095	53103	53104	53108	53112	53113
D-8	1/2	1/2	3-1/2	1/32	12	53115		53119	53123	53131	53132	53136	53140	53141
D-10	5/8	5/8	4	1/32	12	53143		53147	53151	53159	53160	53164	53168	53169
D-12	3/4	3/4	4-1/2	1/32	12	53171		53175	53179	53187	53188	53192	53196	53197
D-16	1	1	7	1/32	6	53199				53215	53216	53220		

THREADING TOOL

E Style Tool - 60° Included Angle

Cuts a standard 60° V-thread. Ground to a sharp point for fine Threading, but can easily be modified for cutting round bottom threads. Can also be used for Chamfering, Notching, and Undercutting.

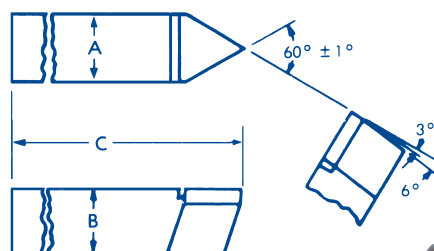

E

TOOL NUMBER	SHANK DIMENSIONS			PKG QTY	Cast Iron & Non-Ferrous Grades			Steel Grades				Multi-purpose
	A	B	C		C2	883	K68	C5	C6	370	K21	MICROGRAIN
E-4	1/4	1/4	2	12	53255	53259	53263	53271	53272	53276	53280	53281
E-5	5/16	5/16	2-1/4	12	53283	53287	53291	53299	53300	53304	53308	53309
E-6	3/8	3/8	2-1/2	12	53311	53315	53319	53327	53328	53332	53336	53337
E-7	7/16	7/16	3	12	53339	53343	53347	53355	53356	53360	53364	
E-8	1/2	1/2	3-1/2	12	53367	53371	53375	53383	53384	53388	53392	53393
E-10	5/8	5/8	4	12	53395	53399	53403	53411	53412	53416	53420	53421
E-12	3/4	3/4	4-1/2	12	53423	53427	53431	53439	53440	53444	53448	53449
E-16	1	1	7	6	53451			53467	53468	53472		

Red stock numbers indicate non-stock items. Quantity extra charge applies.

POLICY & TERMS

Quantity Discounts

Available for orders specifying 500 pieces or more of one style, size and grade.

Non-stock Items

Subject to quantity extra charge.

Warning

Any cutting tool may break or shatter under improper use. Government regulations require the use of safety glasses and other appropriate safety equipment at all times in the vicinity of use.

WARRANTY

Products manufactured by American Carbide Tool Company are fully guaranteed against defects in material and workmanship. If the product has been subjected to improper operating conditions, machine set-up, application of cutting fluids or user alterations, which in the opinion of American Carbide Tool Company would adversely affect the performance of the product, the warranty will not apply.



OFFSET THREADING TOOL

ER & EL Style Tools - Offset 60° Included Angle

Offset for Threading or Boring to a shoulder.



STYLE EL



ER • EL

TOOL NUMBER	SHANK DIMENSIONS				PKG QTY	Cast Iron & Non-Ferrous Grades			Steel Grades			Multi-purpose
	A	B	C	F		C2	883		C5	C6	370	MICROGRAIN
ER-4	1/4	1/4	2	1/16	12	54255	54259		54271	54272	54276	
ER-5	5/16	5/16	2-1/4	1/16	12	54283	54287		54299	54300	54304	54309
ER-6	3/8	3/8	2-1/2	1/16	12	54311	54315		54327		54322	
ER-8	1/2	1/2	3-1/2	3/32	12	54367			54383	54384	54388	54393
ER-10	5/8	5/8	4	3/32	12	54395			54411	54412	54416	54421
ER-12	3/4	3/4	4-1/2	1/8	12	54423	54427		54439	54440	54444	54449
EL-4	1/4	1/4	2	1/16	12	54003	54007		54019	54020	54024	
EL-5	5/16	5/16	2-1/4	1/16	12	54031	54035		54047	54048	54052	54057
EL-6	3/8	3/8	2-1/2	1/16	12	54059	54063		54075	54076	54080	54085
EL-8	1/2	1/2	3-1/2	3/32	12	54115			54131	54132	54136	54141
EL-10	5/8	5/8	4	3/32	12	54143			54159	54160	54164	54169
EL-12	3/4	3/4	4-1/2	1/8	12	54171	54175		54187	54188	54192	54197

END CUTTING OFFSET TOOLS

FR & FL Style Tools - 0° End Cutting Edge Angle

For Turning, Facing, Boring and Straddle Facing close to chuck jaws on lathe and boring mill applications.

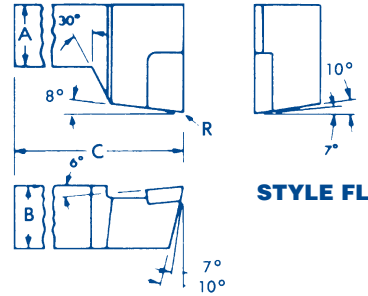

STYLE FL

FR • FL

TOOL NUMBER	SHANK DIMENSIONS			NOSE RADIUS	PKG QTY	Cast Iron & Non-Ferrous Grades			Steel Grades			
	A	B	C			C2	883	K68	C5	C6	370	K21
FR-8	1/2	1/2	3-1/2	1/32	12	55615	55619	55623	55631	55632	55636	55640
FR-10	5/8	5/8	4	1/32	12	55643	55647	55651	55659	55660	55664	55668
FR-12	3/4	3/4	4-1/2	1/32	12	55671	55675	55679	55687	55688	55692	55696
FR-16	1	1	7	1/32	6	55699	55703		55715	55716	55720	
FR-20	1-1/4	1-1/4	8	1/32	Bulk	55727			55743	55744		
FR-24	1-1/2	1-1/2	8	1/16	Bulk	55755			55771	55772		
FR-44	1/2	1	6	1/32	6	55783			55799	55800		
FR-55	5/8	1-1/4	7	1/32	Bulk	55839			55855	55856		
FR-64	3/4	1	6	1/32	Bulk	55867			55883	55884		
FR-66	3/4	1-1/2	8	1/32	Bulk	55895			55911	55912		
FR-85	1	1-1/4	8	1/32	Bulk	55923			55939	55940		
FR-86	1	1-1/2	8	1/32	Bulk	55951			55967	55968		
FL-8	1/2	1/2	3-1/2	1/32	12	55115	55119	55123	55131	55132	55136	55140
FL-10	5/8	5/8	4	1/32	12	55143	55147	55151	55159	55160	55164	55168
FL-12	3/4	3/4	4-1/2	1/32	12	55171	55175	55179	55187	55188	55192	55196
FL-16	1	1	7	1/32	6	55199	55203		55215	55216	55220	
FL-20	1-1/4	1-1/4	8	1/32	Bulk	55227			55243	55244		
FL-24	1-1/2	1-1/2	8	1/16	Bulk	55255			55271	55272		
FL-44	1/2	1	6	1/32	6	55283			55299	55300		
FL-55	5/8	1-1/4	7	1/32	Bulk	55339			55355	55356		
FL-64	3/4	1	6	1/32	Bulk	55367			55383	55384		
FL-66	3/4	1-1/2	8	1/32	Bulk	55395			55411	55412		
FL-85	1	1-1/4	8	1/32	Bulk	55423			55439	55440		
FL-86	1	1-1/2	8	1/32	Bulk	55451			55467	55468		

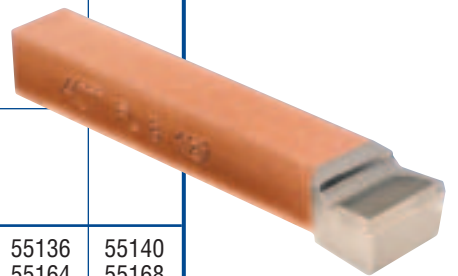

Red stock numbers indicate non-stock items. Quantity extra charge applies.

SIDE CUTTING OFFSET TOOLS

GR & GL Style Tools - 0° Side Cutting Edge Angle

For Turning, Facing, and Boring close to chuck jaws on lathe and boring mill applications.

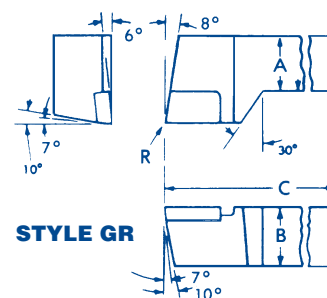

GR • GL

TOOL NUMBER	SHANK DIMENSIONS			NOSE RADIUS	PKG QTY	Cast Iron & Non-Ferrous Grades			Steel Grades			
	A	B	C			C2	883	K68	C5	C6	370	K21
GR-8	1/2	1/2	3-1/2	1/32	12	56615	56619	56623	56631	56632	56636	56640
GR-10	5/8	5/8	4	1/32	12	56643	56647	56651	56659	56660	56664	56668
GR-12	3/4	3/4	4-1/2	1/32	12	56671	56675	56679	56687	56688	56692	56696
GR-16	1	1	7	1/32	6	56699	56703		56715	56716	56720	
GR-20	1-1/4	1-1/4	8	1/32	Bulk	56727			56743	56744		
GR-24	1-1/2	1-1/2	8	1/16	Bulk	56755			56711	56772		
GR-44	1/2	1	6	1/32	6	56783			56799	56800		
GR-55	5/8	1-1/4	7	1/32	Bulk	56839			56855	56856		
GR-64	3/4	1	6	1/32	Bulk	56867			56883	56884		
GR-85	1	1-1/4	8	1/32	Bulk	56923			56939	56940		
GR-86	1	1-1/2	8	1/32	Bulk	56951			56967	56968		
GL-8	1/2	1/2	3-1/2	1/32	12	56115	56119	56123	56131	56132	56136	56140
GL-10	5/8	5/8	4	1/32	12	56143	56147	56151	56159	56160	56164	56168
GL-12	3/4	3/4	4-1/2	1/32	12	56171	56175	56179	56187	56188	56192	56196
GL-16	1	1	7	1/32	6	56199			56215	56216	56220	
GL-20	1-1/4	1-1/4	8	1/32	Bulk	56227			56243	56244		
GL-24	1-1/2	1-1/2	8	1/16	Bulk	56255			56271	56272		
GL-44	1/2	1	6	1/32	6	56283			56299	56300		
GL-55	5/8	1-1/4	7	1/32	Bulk	56339			56355	56356		
GL-64	3/4	1	6	1/32	Bulk	56367			56383	56384		
GL-85	1	1-1/4	8	1/32	Bulk	56423			56439	56440		
GL-86	1	1-1/2	8	1/32	Bulk	56451			56467	56468		



ROUND SHANK BORING TOOLS

TRC Style For Boring to a square shoulder 30° boring bars.

TRE Style

For Boring to a square in 45° boring or with a 15° lead angle in 30° shoulder boring bars.

TRG Style

For shouldering in 90° boring bars. Neutral rake.

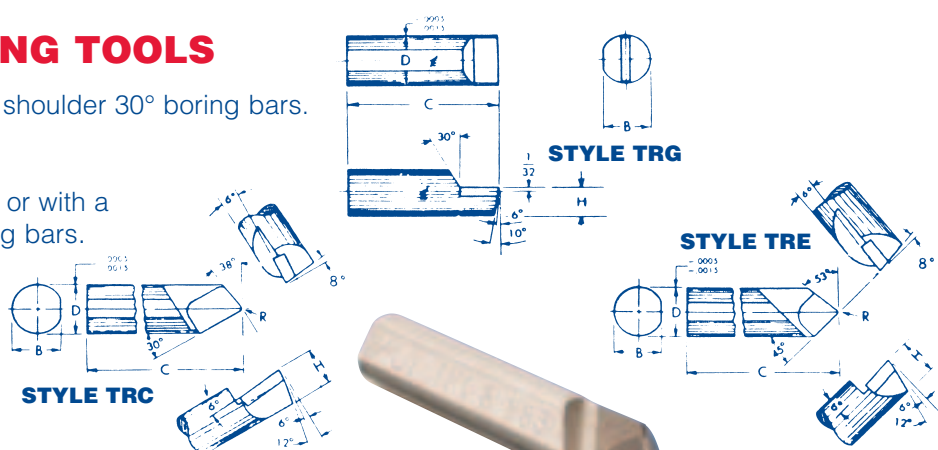

TRC • TRE • TRG

TOOL NUMBER	SHANK DIMENSIONS				NOSE RADIUS	PKG QTY	Cast Iron & Non-Ferrous Grades		Steel Grades		
	A	B	C	F			C2	883	C5	C6	370
TRC-5	5/16	19/64	1-1/2	7/32	1/64	12	57003	57007	57019	57020	57024
TRC-6	3/8	11/32	1-3/4	9/32	1/64	12	57031	57035	57047	57048	57052
TRC-8	1/2	15/32	2-1/2	3/8	1/32	12	57059	57063	57075	57076	
TRE-5	5/16	19/64	1-1/2	7/32	1/64	12	57143	57147	57159	57160	57164
TRE-6	3/8	11/32	1-3/4	9/32	1/64	12	57171	57175	57187	57188	57192
TRE-8	1/2	15/32	2-1/2	3/8	1/32	12	57199		57215	57216	
TRG-5	5/16	19/64	1-1/2	13/16		12	57283	57287	57299	57300	57304
TRG-6	3/8	11/32	1-3/4	1/4		12	57311	57315	57327	57328	57332
TRG-8	1/2	15/32	2-1/2	9/32		12	57339	57343	57355	57356	57360

Red stock numbers indicate non-stock items. Quantity extra charge applies.



SQUARE SHANK BORING TOOLS

TSA Style – For Boring to a square shoulder in a 90° boring bar. High positive rake.

TSC Style – For Boring to a square shoulder in 30° and 45° boring bars. High positive rake.

TSE Style – For Boring to a square shoulder in 45° boring bars or with a 15° lead angle in 30° boring bars. High positive rake.

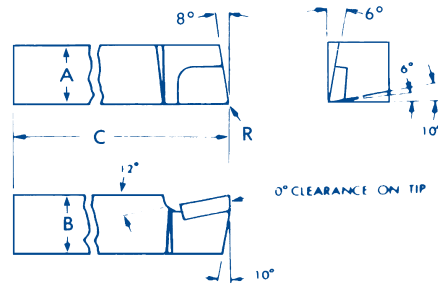

TSA • TSC • TSE

TOOL NUMBER	SHANK DIMENSIONS			NOSE RADIUS	PKG QTY	Cast Iron & Non-Ferrous Grades		Steel Grades		
	A	B	C			C2	883	C5	C6	370
TSA-4	1/4	1/4	1-1/2	1/64	12	58003	58007	58019	58020	58024
TSA-5	5/16	5/16	1-1/2	1/64	12	58031	58035	58047	58048	58052
TSA-6	3/8	3/8	1-3/4	1/64	12	58059	58063	58075	58076	58080
TSA-8	1/2	1/2	2-1/2	1/32	12	58087	58091	58103	58104	58108
TSA-10	5/8	5/8	3	1/32	12	58115		58131	58132	
TSA-12	3/4	3/4	3-1/2	1/32	12	58143	58147	58159	58160	58164
TSB-4	1/4	1/4	1-1/2	1/64	12					
TSB-5	5/16	5/16	1-1/2	1/64	12	58199	58203	58215	58216	58220
TSB-6	3/8	3/8	1-3/4	1/64	12	58227	58231	58243	58244	58248
TSB-8	1/2	1/2	2-1/2	1/32	12	58255	58259	58271	58272	58276
TSB-10	5/8	5/8	3	1/32	12	58283		58299	58300	
TSB-12	3/4	3/4	3-1/2	1/32	12	58311		58327	58328	
TSC-4	1/4	1/4	1-1/2	1/64	12	58339	58343	58355	58356	58360
TSC-5	5/16	5/16	1-1/2	1/64	12	58367	58371	58383	58384	58390
TSC-6	3/8	3/8	1-3/4	1/64	12	58395	58399	58411	58412	58416
TSC-8	1/2	1/2	2-1/2	1/32	12	58423	58427	58439	58440	58444
TSC-10	5/8	5/8	3	1/32	12	58451		58467	58468	
TSC-12	3/4	3/4	3-1/2	1/32	12	58479	58483	58495	58496	58498
TSD-4	1/4	1/4	1-1/2	1/64	12					
TSD-5	5/16	5/16	1-1/2	1/64	12		58535	58547	58548	
TSD-6	3/8	3/8	1-3/4	1/64	12		58563	58575	58576	
TSD-8	1/2	1/2	2-1/2	1/32	12		58591	58603	58604	
TSD-10	5/8	5/8	3	1/32	12	58615		58631	58632	
TSD-12	3/4	3/4	3-1/2	1/32	12	58643		58659	58660	
TSE-4	1/4	1/4	1-1/2	1/64	12	58671	58675	58687	58688	58692
TSE-5	5/16	5/16	1-1/2	1/64	12	58699	58703	58715	58716	58720
TSE-6	3/8	3/8	1-3/4	1/64	12	58727	58731	58743	58744	58748
TSE-8	1/2	1/2	2-1/2	1/32	12	58755	58759	58771	58772	58776
TSE-10	5/8	5/8	3	1/32	12	58783		58799	58800	
TSE-12	3/4	3/4	3-1/2	1/32	12	58811	58815	58827	58828	58832
TSF-4	1/4	1/4	1-1/2	1/64	12					
TSF-5	5/16	5/16	1-1/2	1/64	12	58867		58883	58884	
TSF-6	3/8	3/8	1-3/4	1/64	12	58895		58911	58912	
TSF-8	1/2	1/2	2-1/2	1/32	12	58923		58939	58940	
TSF-10	5/8	5/8	3	1/32	12	58951		58967	58968	
TSF-12	3/4	3/4	3-1/2	1/32	12	58979		58995	58996	

Red stock numbers indicate non-stock items. Quantity extra charge applies.

DISTRIBUTED BY:



P.O. Box 7070 • Canton, Ohio 44705
Ph: 330.455.2009 • Fax: 330.453.8498

www.americancarbidetool.com